



上海松铭传动机械有限公司
SHANGHAI SONGMING TRANSMISSION MACHINERY CO.,LTD

联轴器配件标准选型参数



联轴器系列



联轴器系列



GR

GR(XL)星型联轴器缓冲垫 GR(XL)star coupling plum cushion

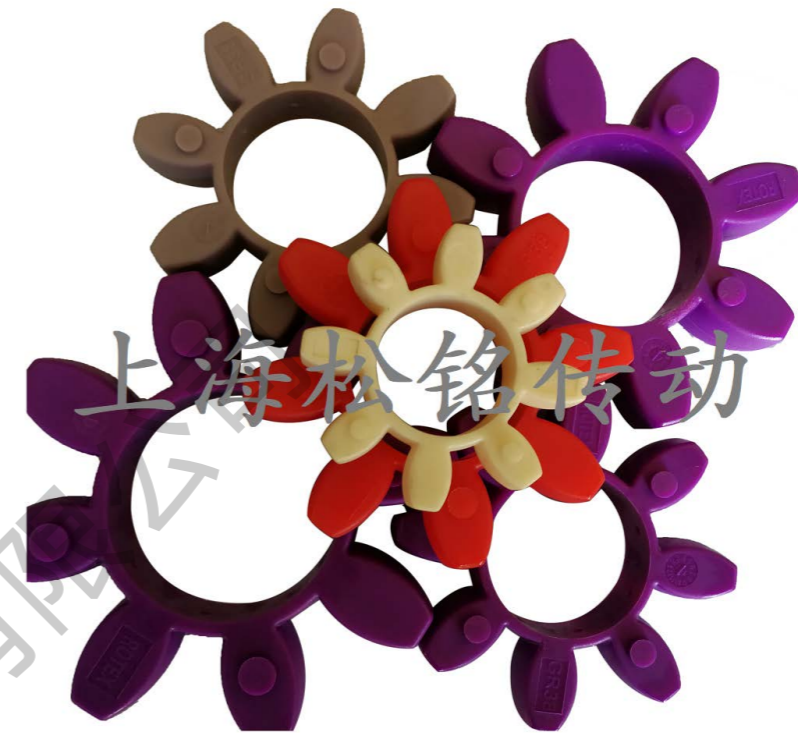
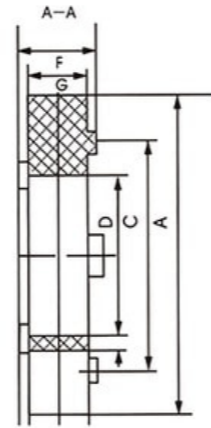

产品用途

本标准适用于传动机械联轴器缓冲作用于传动轴的联接

扭矩: 22.4-2500NM

产品硬度:黄色92A蓝色95A红色98A

使用温度:-40~100°C

Product use:

This products are used for mechanical shaft coupling,As a joint in the transmission shaft

Torque:22.4-2500NM

Abrasion: <0.05cm³/1.61km

Product hardness:Yellow SHA92, blue SHA95, Red

SHA98 Service temperature:-40-100°C



型号	外径D	内径d	厚度n1	厚度n2	瓣数
GR-19	40	18	14.5	12	6
GR-24	54	26	15.2	14	8
GR-28	65	30	19	15	8
GR-38	80	38	22	18	8
GR-42	95	46	24	20	8
GR-48	104	51	25.5	21	8
GR-55	120	60	27	22	8
GR-65	135	68	32	26	8
GR-75	160	80	37	30	10
GR-90	199	100	42	34	10
GR-100	225	113	--	38	10
GR-110	255	127	--	42	10
GR-125	290	147	--	46	10
GR-140	320	165	--	50	10
GR-160	370	190	--	57	10
GR-180	420	220	--	64	12

GS

GS无齿隙联轴器弹性体

GS Backlash free tight coupling elastomer

用途材质

本标准适用于传动机械联轴器缓冲
作用于传动轴的联接。

扭矩: 22.4-2500NM

产品硬度:黄色92A 蓝色95A 红色
98A

使用温度:-40~100°C

Product use:

This products are used for mechanical
shaft coupling,As a joint in the
transmission shaft

Torque:22.4-2500NM

Product hardness:Yellow SHA92, blue
SHA95, Red SHA98

Service temperature:-40-100°C

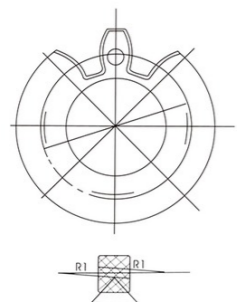
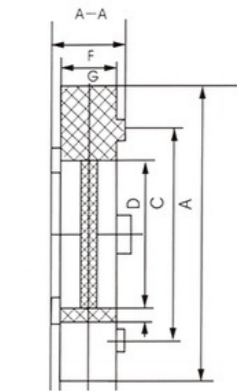

型号	外径D	内径d	厚度n1	厚度n2	瓣数
GS-5	10	--	6	4	4
GS-7	14	--	8	6	4
GS-9	20	7	10	8	4
GS-12	25	8	12	10	4
GS-14	30	10	12	10	4
GS-19	40	18	14.5	12	6
GS-24	54	26	15.2	14	8
GS-28	65	30	19	15	8
GS-38	80	38	22	18	8
GS-42	95	46	24	20	8
GS-48	104	51	25.5	21	8
GS-55	120	60	27	22	8
GS-65	135	68	32	26	8
GS-75	160	80	37	30	10



MT/ML

MT/ML联轴器梅花垫
MT/ML coupling plum
cushion

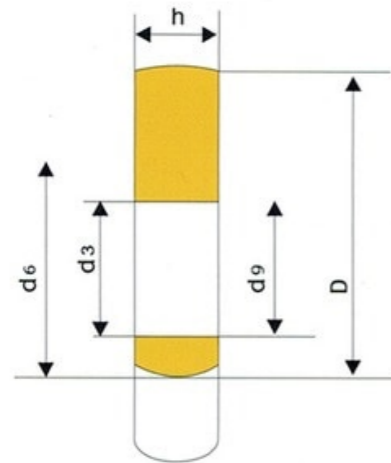

产品用途

用于重型机械联轴器缓冲作用于传动轴的链接

材质:聚氨酯(TPU)

扭矩: 22.4-2500NM

产品硬度: 90A \pm 20 95A \pm 20配

套联轴器代号: ML、MLL

Product use:

Product use: Used as a link for all kinds of heavy mechanical coupling buffer acting on the transmission shaft

Material quality: Polyurethane(TPU)

Torque: 22.4-2500NM

hardness: 90A \pm 2° 95A \pm 20 Supporting

coupling code: ML, MLL

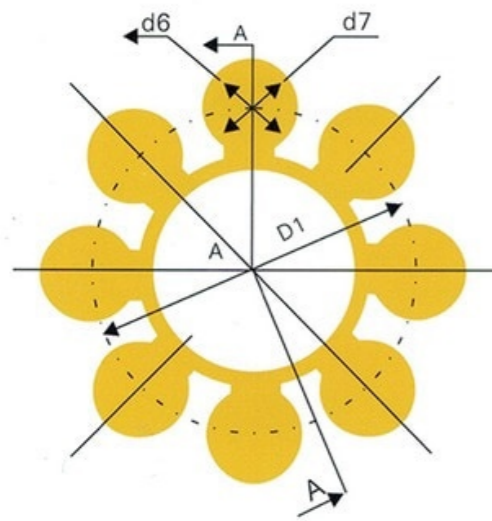

型号	外径	内径	厚度	花数	单价
	(D)	(d)	(n)		
MT-1	48	19	12	4	
MT-2	68	28	18	6	
MT-3	80	35	18	6	
MT-4	100	42	20	6	
MT-5	120	55	25	6	
MT-6	140	65	30	6	
MT-7	165	90	30	8	
MT-8	195	100	35	8	
MT-9	225	115	35	10	
MT-10	255	140	45	10	
MT-11	295	170	50	10	
MT-12	355	215	55	12	
MT-13	391	250	55	12	

H

H型弹性块

H type of elastic block

产品用途

本标准适用于传动机械联轴器
缓冲作用于传动轴的联接。

扭矩: 22.4-2500NM

磨耗: $<0.05\text{cm}^3/1.61\text{km}$

产品硬度: $90A \pm 5$

使用温度: $-20-80^\circ\text{C}$

Product use:

The standard is applicable for all
kinds of transmission machinery
coupling buffer acting on the
transmission shaft connection.

Torque: 22.4-2500NM

Abrasion $<0.05\text{cm}^3/1.61\text{km}$

Product hardness: $90A \pm 5$

Service temperature: $-20-80^\circ\text{C}$

型号 H块A型	单价	型号 H块B型
A140		B95
A160		B110
A180		B125
A200		B140
A225		B160
		B180
		B280
		B200
		B240

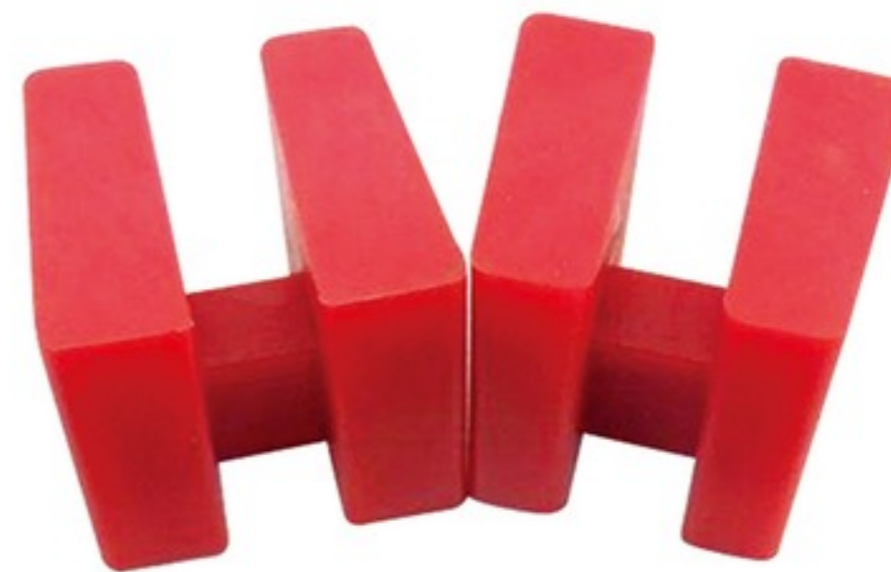
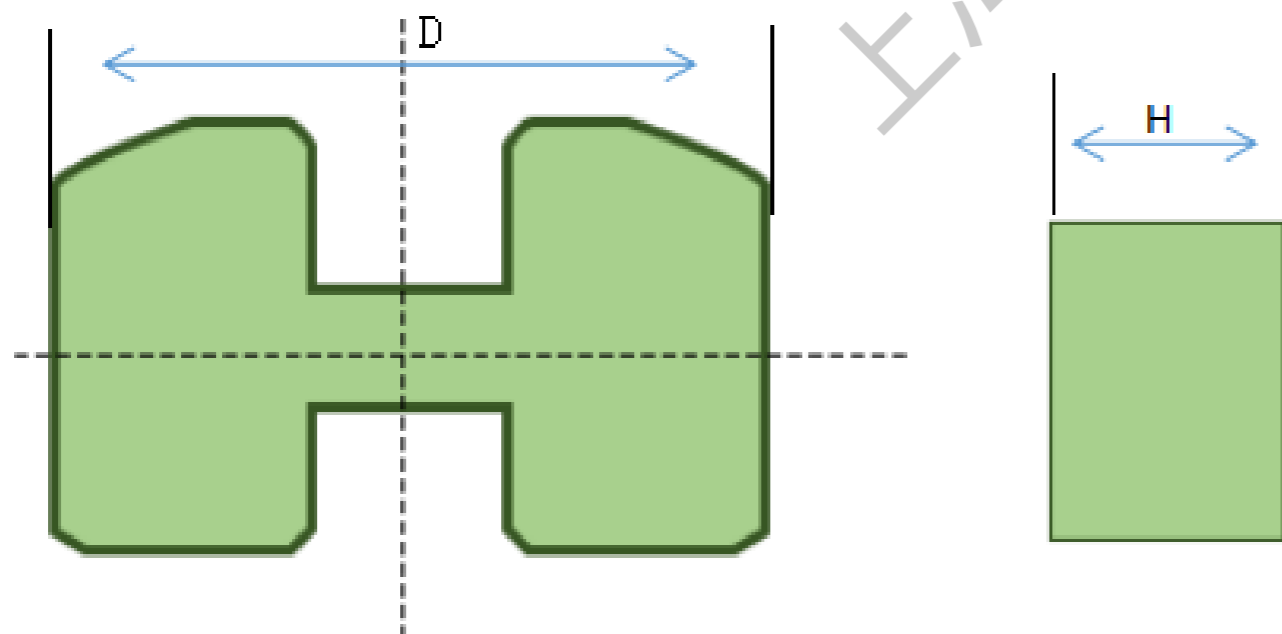

L

L爪式联轴器梅花垫

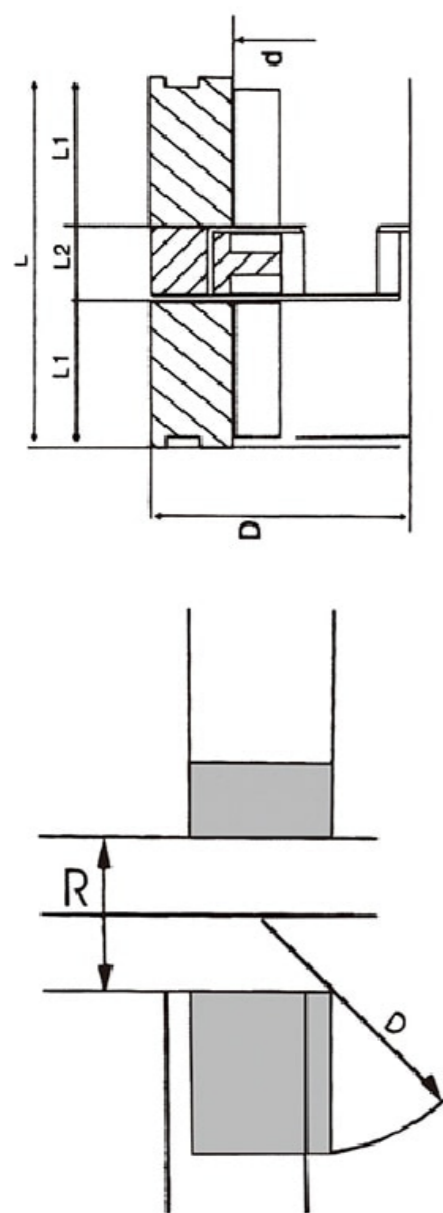

型号	扭矩		最高回转速	D	L	L1	L2	d		惯性矩
	最大	最小						最大max	最小min	
L-35	0.05	0.15	6000	16.1	20.5	6.5	7.5	4	8	0.1
L-50	0.15	0.45	4500	27	43.2	15.5	12.2	6	16	1
L-70	0.3	0.9	3600	35	49.2	18.5	12.2	6	20	3.3
L-755	0.5	1.5	3600	45	54.4	21	12.4	8	26	9.1
L-90	0.8	2.4	3000	54	55	21	13	10	28	15
L-05	1	3	3000	55	61	24	13	10	28	17
L-99	2	6	3000	66	73	30	18	12	36	42
L-100	2.5	7.5	3000	66	88	35	18	12	36	43
L-110	5	15	2500	85	110	44	22	12	48	147
L-150	10	30	2500	96	118.5	46	26.5	16	46	258
L-190	15	45	2000	115	138.5	56	26.5	16	58	628
L-225	20	60	2000	127	152.5	63.5	26.5	18	60	1685
L-276	25	75	2000	157	200	79	41	22	73	5256

Serial NO	D外径 Outside diameter	d内径 Inside diameter	H厚度 Thickness	瓣数 Lamella QTY
T-75	75	31	15	6
T-80	80	40	15	6
T-85	85	40	17	6
T-90	90	40	18	6
T-95	95	42	20	6
T-100	100	52	22	6
T-105	105	52	22	6
T-110	110	52	22	6
T-120	120	60	25	6
T-125	125	62	25	6
T-130	130	65	25	6
T-135	135	68	25	6
T-140	140	68	26	6
T-145	145	70	27	6
T-150	150	80	28	6
T-155	155	80	28	8
T-165	165	82	30	6
T-170	170	83	30	6
T-175	175	85	30	6
T-180	180	90	30	6
T-200	200	110	35	8
T-210	210	100	38	6

T

T型六角块 T-type hexagonal blocks

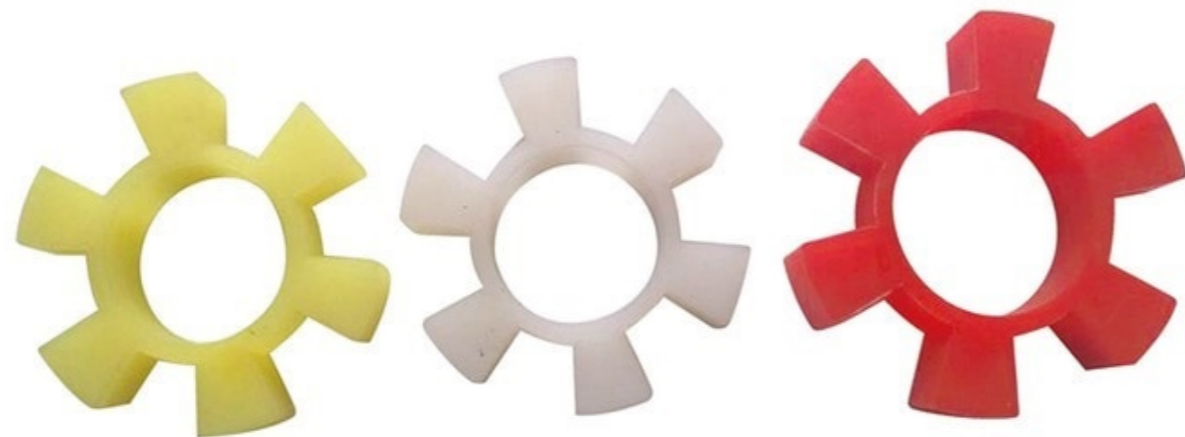
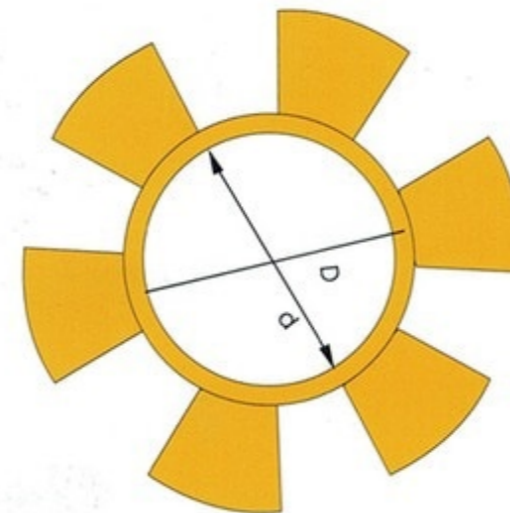
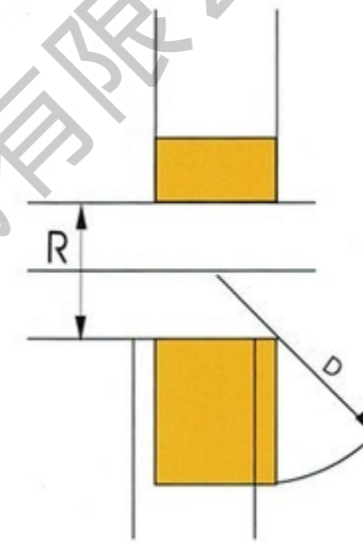

材质:优质国产聚氨酯(TPU)

产品用途:用于工业水泵传动链接缓冲作用使用

温度:-30~+80

磨耗: <0.05cm³ / 1.61km

颜色:白色/黄色

产品硬度: 90A ±2

Product use:domestically produced polyurethane (TPU)

Product use: Used for various industrial pumps drive linking with buffering effect

Service temperature:~30-+80

Abrasion: <0.05cm³/1.61km

Color:White/Yellow

Product hardness: 90A ±2

HRC

梅花型联轴器弹性缓冲块

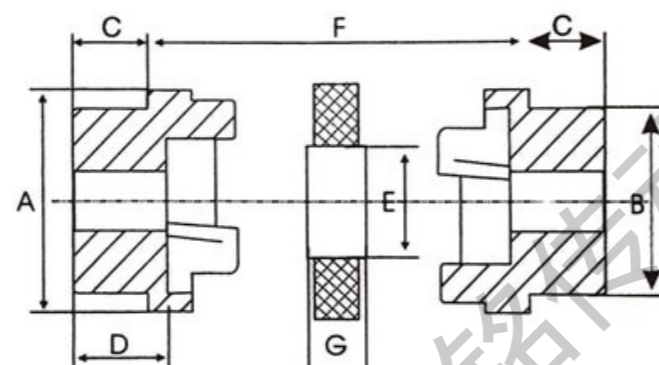

型号	外径D	内径d	厚度
HRC-70	58	30	17
HRC-90	72	31	22
HRC-110	95	41	28
HRC-130	115	47	35
HRC-150	133	62	40
HRC-180	160	73	44
HRC-230	200	93	59
HRC-280	252	116	71

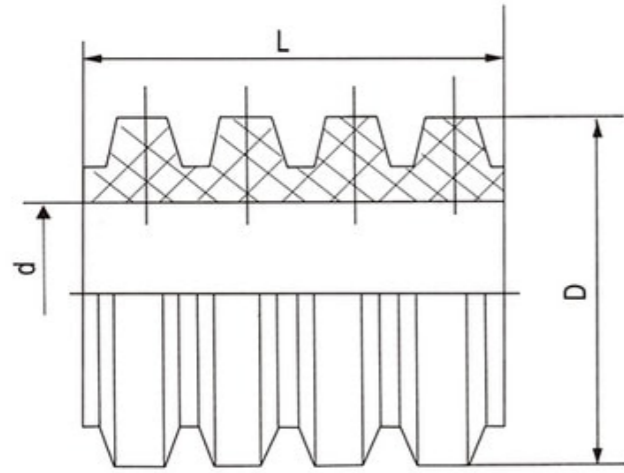

产品用途

本标准适用于弹性套柱销联轴器用以及机械设备起减振缓冲作用

产品硬度: 85A±5

标准: GB4323-84

Product use

Material quality: Product use: The standard applies to elastic sleeve pin coupling and various mechanical equipment for vibration attenuation and buffering effect.

Product hardness: 85A±5

Standard source: GB4323-84

Serial NO	规格 SPECIFICATION		
	d	D	L
LT-8	8	16	10
LT-10	10	19	15
LT-12	12	24	28
LT-14	14	26	28
LT-18	18	35	36
LT-24	24	45	44
LT-30	30	56	56
LT-38	38	71	72
LT-45	45	85	88



四连体弹性套 Four component combined elastic sleeve

Serial NO	d	D	L
ZT-8	8	16	10
ZT-10	10	19	15
ZT-14	14	28	27
ZT-38	38	71	72

Serial NO	d	D	L
ZT-18	8	36	35
ZT-24	24	45	44
ZT-30	30	56	55
ZT-45	45	85	88

弹性圈 (分体) Elastic ring (split-ed part)

Serial NO	d	D	L
FT-10	10	20	7
FT-12	12	24	7
FT-14	14	28	7
FT-14	14	29	7
FT-18	18	36	9
FT-18	18	38	9
FT-24	24	45	11

Serial NO	d	D	L
FT-24	24	48	11
FT-28	28	56	15
FT-30	30	56	15
FT-30	30	62	14
FT-38	38	71	18
FT-45	45	91	22
FT-45	45	85	23

LT

LT柱销联轴器弹性套

上海松铭传动机械有限公司

LLA 轮胎开口式联轴器配件



LA 轮胎联轴器的特点:

●本联轴器是一种弹性联轴器，具有减震缓冲和轴间偏移补偿性能，工作温度-20~80摄氏度，转递转矩10~20000N.M, 适于潮湿、多尘、有冲击、振动、正反转多变和起动频繁的工作条件，拆装方便，不需润滑。

型号规格	外径	长度	子口长	内径	子口直径
LLA1	60	-	-	-	-
LLA2	100	26	1.7	68	74
LLA3	135	40	5	90	95
LLA4	180	57	5	108	124
LLA5	210	67	5	133	148
LLA6	265	77	5	165	185
LLA7	310	85	5	195	215
LLA8	400	108	5	255	285
LLA9	450	116	5	290	316
LLA10	550	155	5	340	385

上海松铭传动机械有限公司

LLB 轮胎式联轴器配件



型号规格	直径	厚度	螺母	数量	分度圆
LLB1	60	26	M4	6	30
LLB2	100	37	M6	6	50
LLB3	120	39	M8	6	65
LLB4	140	45	M10	6	75
LLB5	160	51	M10	6	85
LLB6	185	58	M12	6	100
LLB7	220	67	M12	6	112
LLB8	265	82	M12	6	140
LLB9	310	106	M16	6	170
LLB10	340	106	M16	6	180

上海松铭传动机械有限公司

UL 轮胎式联轴器配件



型号规格	直径	厚度	螺母	数量	分度圆
UL1	80	20	M5	6	42
UL2	100	26	M6	6	51
UL3	120	32	M8	6	62
UL4	140	38	M8	6	69
UL5	160	45	M10	6	80
UL6	180	50	M10	6	90
UL7	200	56	M10	6	104
UL8	220	63	M12	6	110
UL9	250	71	M12	8	130
UL10	280	80	M12	8	148
UL11	320	90	M16	6	165
UL12	360	100	M16	6	188
UL13	400	110	M16	8	210

上海松铭传动机械有限公司

NL 尼龙联轴器配件



尼龙套型号	尼龙套外径	齿数	模数
NL1	40	20	1.5
NL2	52	45/28	1
NL3	66	34	1.5
NL4	83	45	1.5
NL5	93	38	2
NL6	100	40	2
NL7	115	36/45	2.5/2
NL8	140	45/36	3
NL9	175	45	3
NL10	220	46	4